

Wiring Harness Rebuilt

Another obstacle I had to come over was the hiring harness. Since the car had a front end collision the portion of the wiring harness that operates the condenser fans was missing. Moreover I found out to my surprise that the harness had been "repaired" by some knucklehead in the past; many of the cables were cut out, some replaced with completely unsuitable cables, no color code was followed, must have used many rolls of vinyl tape which stick your fingers together when touched ... Generally speaking the harness was a completely uncomfortable item to work with.

Since I am doing a high standards job I decided to rebuilt the harness by using new cables and connectors. These are really cheap and can be found at your local automotive electric shops.



Here is an example of a connector that needed attention. Notice the amount of vinyl tape wrapped around the harness. The moment I got rid of this ugly tape, I found a real mess underneath. Cables were cut, twisted together (not even soldered !), with no insulation (!) and the most dangerous was the fact that some of these cables had melted insulation... This means that during the past a serious electrical fault occurred in the donor car.

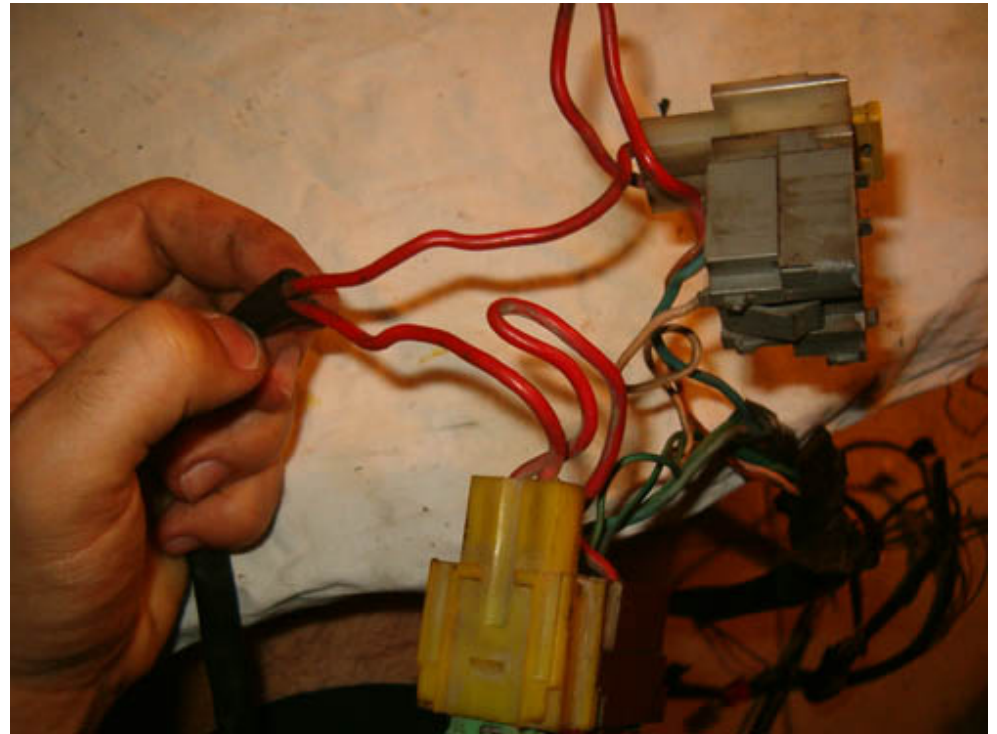

Relay and fuse holders...

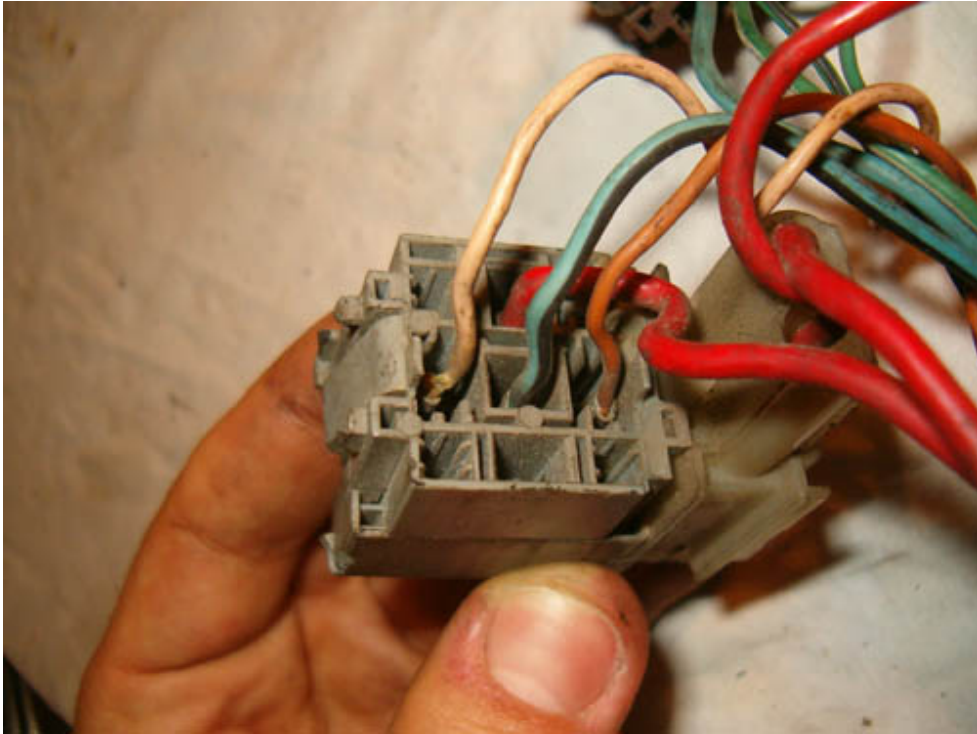

It is not that bad here ...

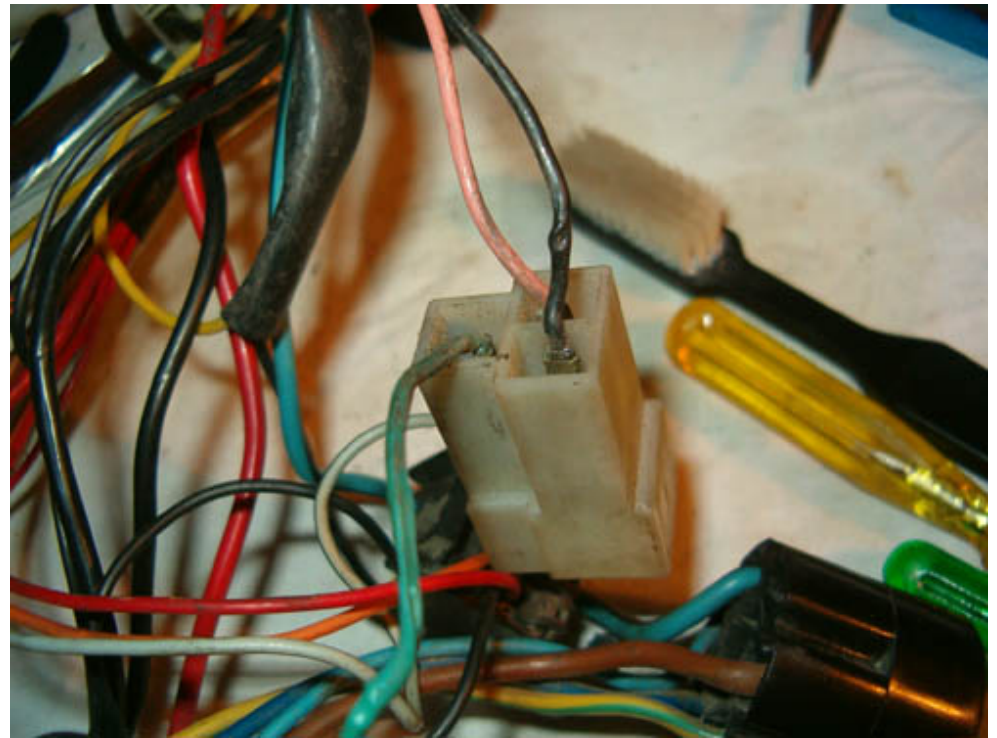
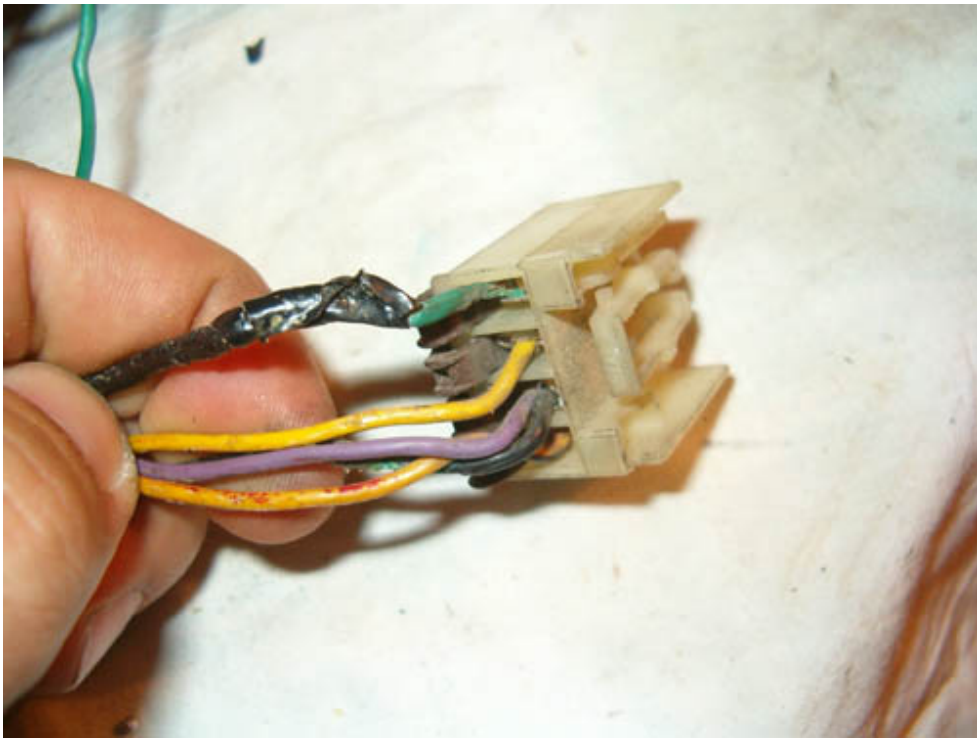

But here attention is needed .

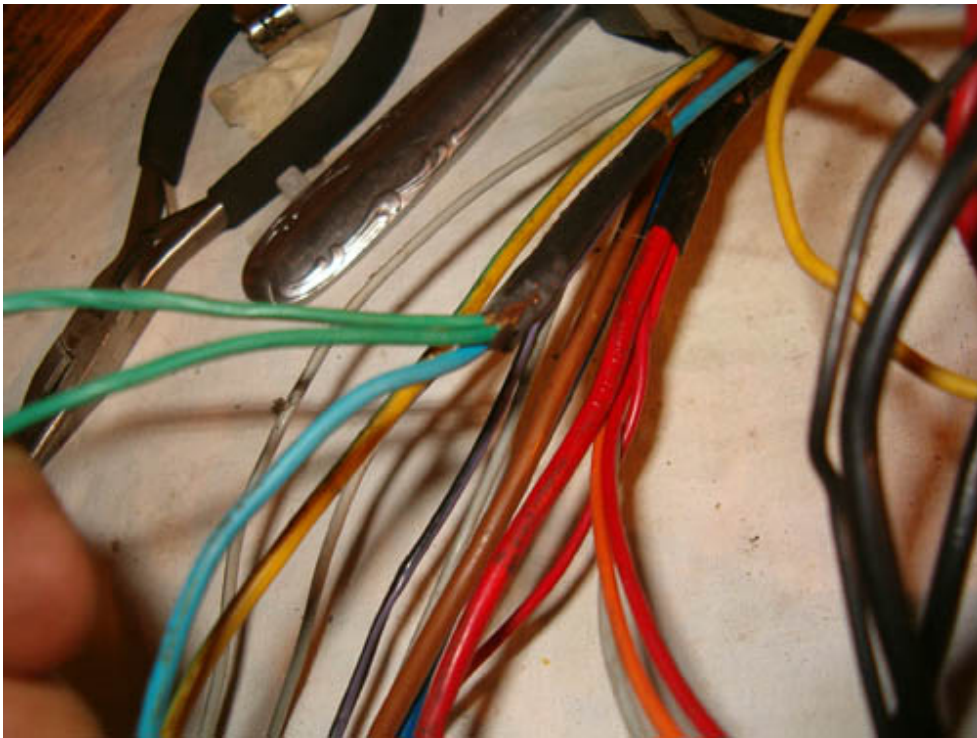

more melted cables...



This is the heater fan switch connector. Strange enough there was no fault here.



New cables which will replace the old, melted ones.



Cloth tape along with new spade connectors and relays. The harness taken from the donor car did not have any relays, so I got two new ones from Alfa. Notice the nuts on the left; these are special nuts from Alfa, required to keep in place pipes etc.

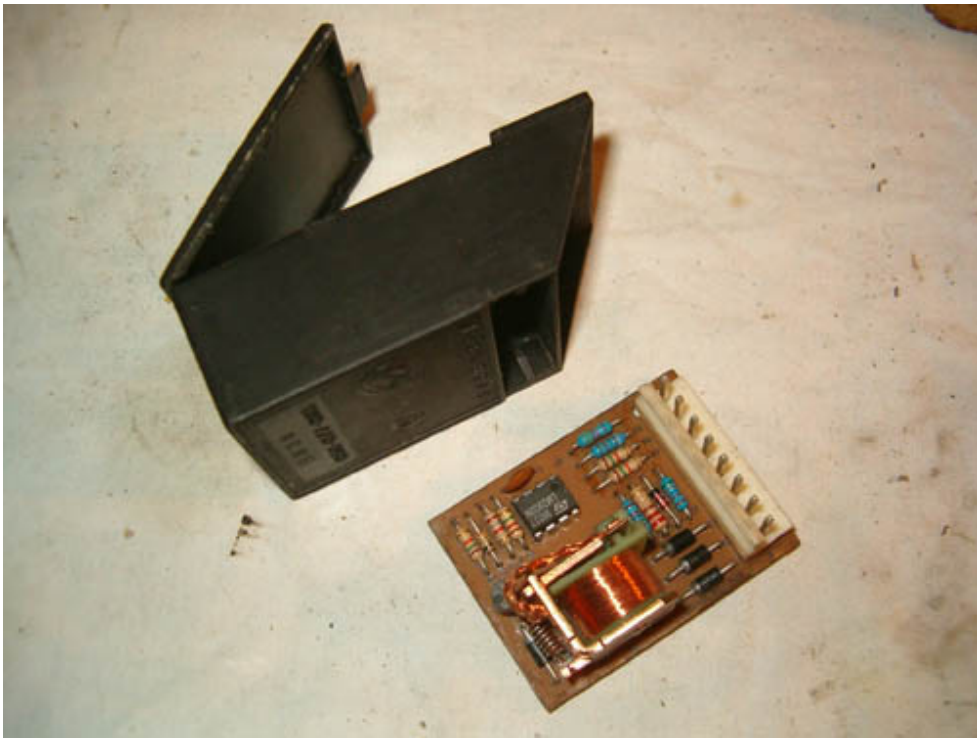

Electronic Thermostat: This device receives input from two sources. First is the frost sensor on the evaporator pipes and second is the A/C switch on the instrument panel. When the values from the two sources are equal then this device stops operation of the compressor and condenser fans; as temperature on the evaporator pipe increases then the thermostat triggers compressor and condenser fan operation and the system cycles again. This process of A/C operation is called cycle on / cycle off.



New Trinary Valve. Its purpose is to trigger right side condenser fan and in the meantime it serves as a minimum/maximum pressure switch in the case of a malfunctioning subsystem of the A/C unit (compressor or condenser fan). It is installed on the drier filter in order to measure system pressure and act on each case.

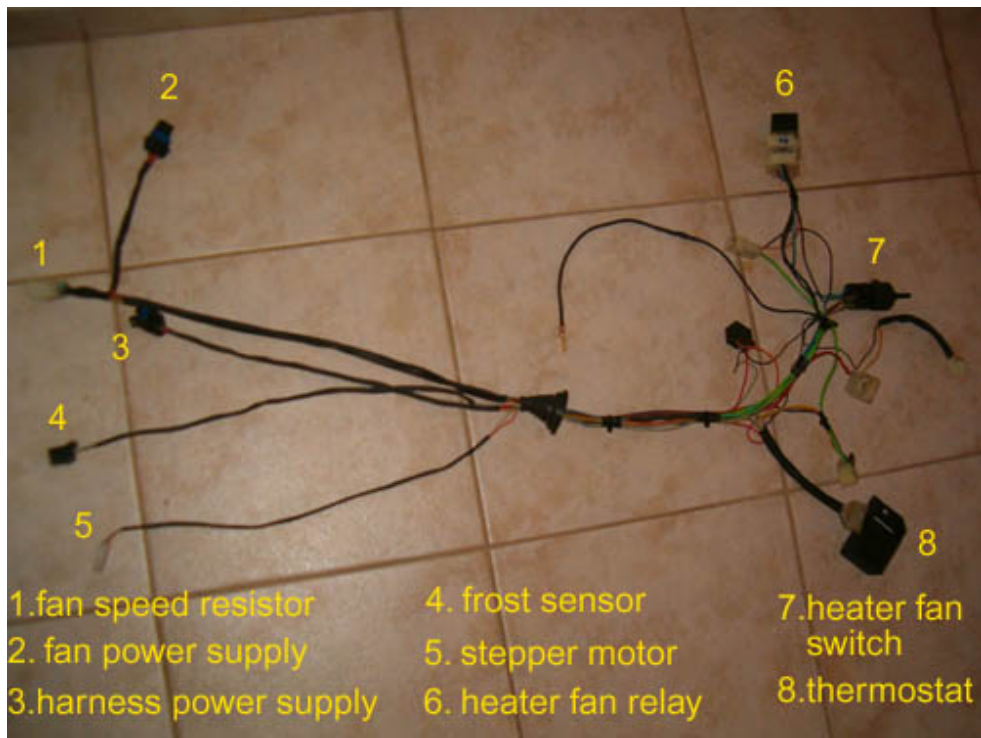

This is the evaporator harness after the rebuilt ...

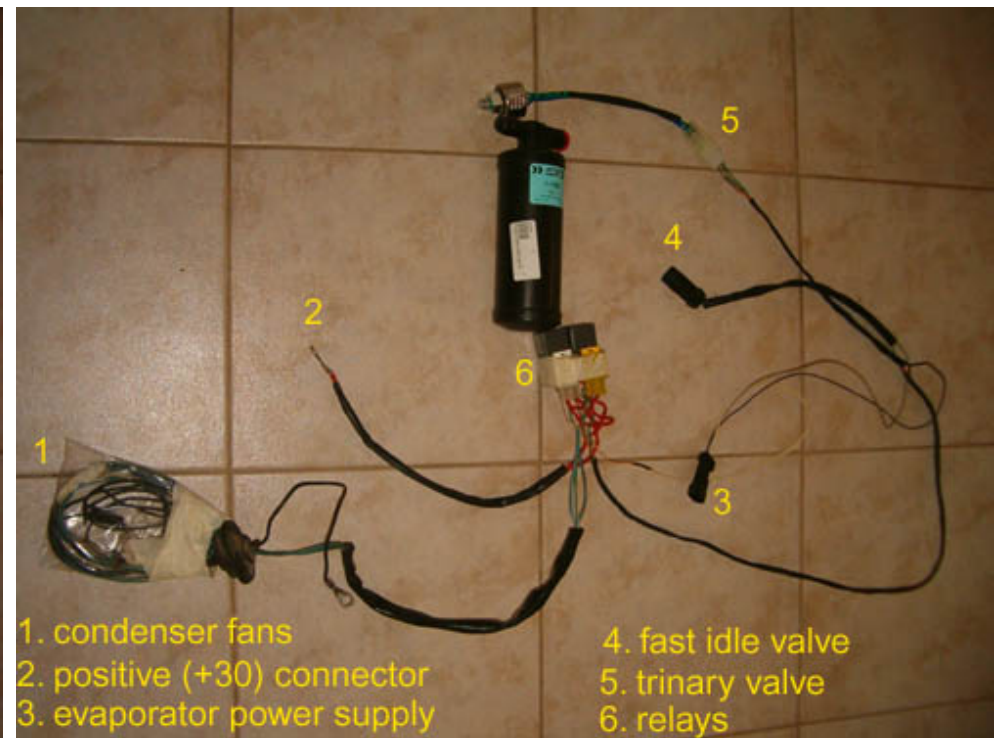

... and the main harness. A note here regarding part #1; Since I don't yet know the length of the condenser fan cables required, I will patch them once the harness and condensers are installed on the car

As you may have understood, the A/C harness is comprised in two parts. Evaporator part and main harness. These two parts are connected via connector #3 as seen above

Let's now move on to installation of the evaporator & harness to the car.